



Model RL2000

QUICK REFERENCE GUIDE



THIS AREA FOR SERVICE PROVIDER
CONTACT INFORMATION:

MANAGEMENT FUNCTIONS

- ACCESS INSTRUCTIONS -

1. AT ATM WELCOME SCREEN, PRESS AND HOLD DOWN THE <CTRL> KEY (LOWER-RIGHT CORNER OF KEYPAD), PRESS <1> KEY, THEN RELEASE BOTH KEYS. THE TOP MENU WILL BE DISPLAYED.
2. AT THE TOP MENU, SELECT MANAGEMENT FUNCTIONS OPTION. ENTER PASSWORD AND SELECT <ENTER>. THE MANAGEMENT FUNCTIONS MAIN MENU IS DISPLAYED.

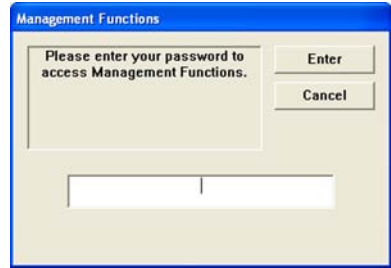

RESTART / SHUTDOWN TERMINAL

FOLLOW ACCESS INSTRUCTIONS TO ENTER MANAGEMENT FUNCTIONS. SELECT SYSTEM PARAMETERS.

RESTART TERMINAL: THIS FUNCTION REBOOTS THE TERMINAL.

SHUTDOWN TERMINAL: THIS FUNCTION POWERS-DOWN THE TERMINALS OPERATING SYSTEM. WHEN PROMPTED THAT SHUTDOWN IS COMPLETE, TURN ON/OFF SWITCH ON POWER SUPPLY TO <OFF> POSITION.

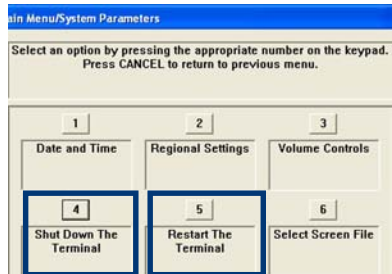

DIAGNOSTICS

FOLLOW ACCESS INSTRUCTIONS TO ENTER MANAGEMENT FUNCTIONS. SELECT DIAGNOSTICS > DISPENSER.

PURGE: THIS INSTRUCTS THE DISPENSER TO REMOVE ANY NOTES (JAMS) IN FEED PATH.

TEST DISPENSE: THIS INSTRUCTS THE DISPENSER TO DISPENSE *MINIMUM* ONE NOTE FROM EACH INSTALLED CASSETTE INTO THE REJECT CASSETTE/ AREA.

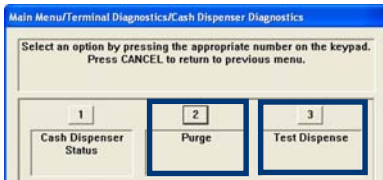

SELECT DIAGNOSTICS > PRINTER.

RESET / TEST RECEIPT PRINTER: THIS INSTRUCTS THE PRINTER TO RE-INITIALIZE AND PERFORM A TEST PRINTOUT .

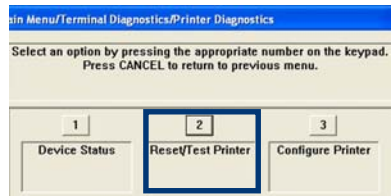
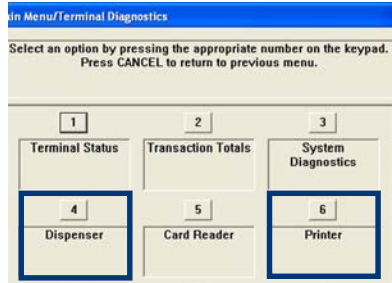

CLOSE FUNCTIONS

FOLLOW ACCESS INSTRUCTIONS TO ENTER MANAGEMENT FUNCTIONS. SELECT TERMINAL CLOSE FUNCTIONS.

DAY CLOSE: THIS OPTION IS USED TO COMPLETE DAILY BALANCING OF THE ATM WITH THE PROCESSOR. TOTALS ARE CLEARED AND SWITCHED TO THE NEXT BUSINESS DAY.

TRIAL CLOSE: THIS OPTION FUNCTIONS LIKE A DAY CLOSE EXCEPT THE TOTALS ARE NOT CLEARED.

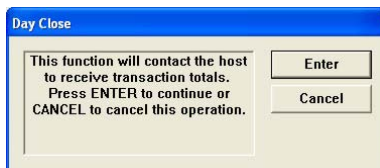

A dialog box titled "Day Close" with a blue header. The main text reads: "This function will contact the host to receive transaction totals. Press ENTER to continue or CANCEL to cancel this operation." To the right of the text are two buttons: "Enter" and "Cancel".

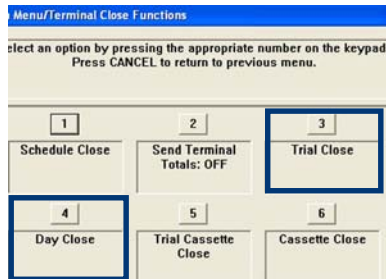

A screen titled "Menu/Terminal Close Functions" with a blue header. Below the header is the instruction: "Select an option by pressing the appropriate number on the keypad. Press CANCEL to return to previous menu." The screen displays a grid of six options, each with a number in a box above it: 1. Schedule Close, 2. Send Terminal Totals: OFF, 3. Trial Close, 4. Day Close, 5. Trial Cassette Close, 6. Cassette Close. The "Day Close" option (4) is highlighted with a blue border.

JOURNAL FUNCTIONS

FOLLOW ACCESS INSTRUCTIONS TO ENTER MANAGEMENT FUNCTIONS. SELECT JOURNAL.

PRINT LAST X: TO VIEW/PRINT PREVIOUSLY AUDITED OR UNAUDITED RECORDS, USE THE PRINT LAST X OPTION.

EXAMPLE: ENTERING THE NUMBER '50' WILL LET YOU VIEW THE LAST 50 TRANSACTIONS/EVENTS THAT HAVE OCCURRED. YOU MAY PRINT TO THE RECEIPT PRINTER.

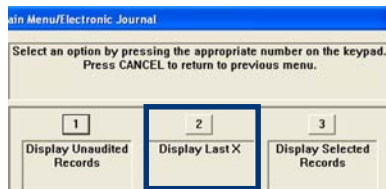

A screen titled "Main Menu/Electronic Journal" with a blue header. Below the header is the instruction: "Select an option by pressing the appropriate number on the keypad. Press CANCEL to return to previous menu." The screen displays a grid of three options, each with a number in a box above it: 1. Display Unaudited Records, 2. Display Last X, 3. Display Selected Records. The "Display Last X" option (2) is highlighted with a blue border.

TERMINAL CONFIGURATION REPORT

FOLLOW ACCESS INSTRUCTIONS TO ENTER MANAGEMENT FUNCTIONS. SELECT DIAGNOSTICS > TERMINAL STATUS.

CONFIGURATION SUMMARY: THIS SUMMARY IS A COMPREHENSIVE REPORT OF CURRENT TERMINAL CONFIGURATION AND HARDWARE STATUS INFORMATION.

NOTE: IT IS HIGHLY RECOMMENDED THAT THIS REPORT BE PRINTED AND SAVED AFTER INITIAL SETUP AND WHENEVER CHANGES ARE MADE TO THE TERMINALS CONFIGURATION.

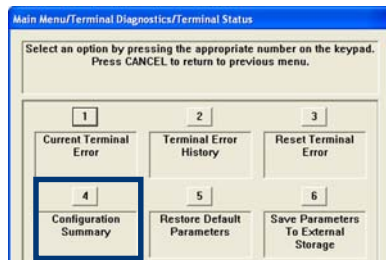

A screen titled "Main Menu/Terminal Diagnostics/Terminal Status" with a blue header. Below the header is the instruction: "Select an option by pressing the appropriate number on the keypad. Press CANCEL to return to previous menu." The screen displays a grid of six options, each with a number in a box above it: 1. Current Terminal Error, 2. Terminal Error History, 3. Reset Terminal Error, 4. Configuration Summary, 5. Restore Default Parameters, 6. Save Parameters To External Storage. The "Configuration Summary" option (4) is highlighted with a blue border.

CASSETTE CLOSE FUNCTIONS

FOLLOW ACCESS INSTRUCTIONS TO ENTER MANAGEMENT FUNCTIONS. SELECT TERMINAL CLOSE FUNCTIONS. SELECT CASSETTE CLOSE.

- ❶ SELECT CASSETTE(S) TO CLOSE. A CHECK MARK (✓) IDENTIFIES WHICH CASSETTE(S) ARE SELECTED. PRESS <ENTER>.

- ❷ A CLOSE REPORT IS DISPLAYED TO BE PRINTED OR SAVED. THIS OPERATION WILL RESET THE NUMBER OF BILLS IN THE CASSETTE(S) TO ZERO (0). PRESS <ENTER>.

- ❸ REMOVE AND REPLENISH THE SELECTED CASSETTE(S).

PROCEDURES FOR SPECIFIC DISPENSING MECHANISMS CASSETTE REPLENISHMENT ARE ON THE FOLLOWING PAGES.

NOTE: IF AN NMD-50 DISPENSER IS INSTALLED, WAIT FOR THE CASSETTES TO UNLOCK (THIS IS DONE AUTOMATICALLY).

- ❹ AFTER CASSETTE(S) HAVE BEEN REINSERTED IN THE DISPENSER, PRESS <ENTER>.

NOTE: IF AN NMD-50 DISPENSER IS INSTALLED, WAIT FOR THE CASSETTES TO LOCK (THIS IS DONE AUTOMATICALLY). PRESS <ENTER> IF APPLICABLE.





- ❺ PLACE SELECTED CASSETTE(S) IN SERVICE. PRESS <ENTER>. **NOTE: THE NMD-50 CASSETTES MUST BE LOCKED AND IN SERVICE FOR NORMAL OPERATION.**

- ❻ ENTER CASSETTE QUANTITY (NUMBER OF NOTES, NOT VALUE) FOR THE SELECTED CASSETTE(S). PRESS <ENTER> TO ACCEPT ENTRY. REPEAT FOR EACH SELECTED CASSETTE.

- ❼ A TRIAL CASSETTE CLOSE REPORT AUTOMATICALLY IS DISPLAYED TO BE PRINTED OR SAVED. PRINT AND RETAIN A COPY FOR STARTING POINT REFERENCE. PRESS <ENTER> TO RETURN TO CLOSE FUNCTIONS.

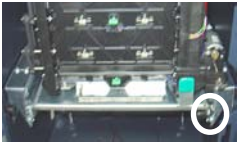
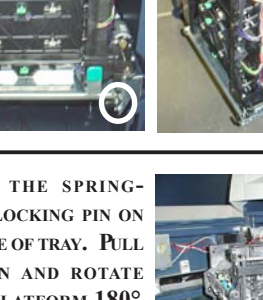
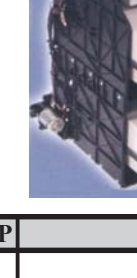
REPLENISH TDM CASSETTE(S) (TDM-250)





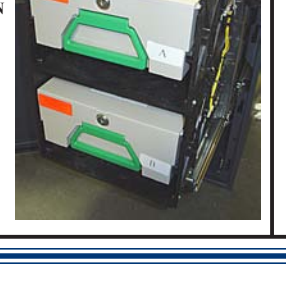
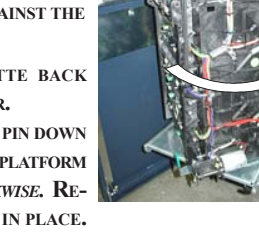

STEP	ACTION
1	<p>UNLOCK/OOPEN DISPENSER SECURITY DOOR. RELEASE THE SLIDE LOCKING LEVER AND EXTEND THE DISPENSER MOUNTING TRAY FULLY.</p>  
2	<p>LOCATE THE SPRING-LOADED LOCKING PIN ON UNDERSIDE OF TRAY. PULL PIN DOWN AND ROTATE SWIVEL PLATFORM 180° CLOCKWISE. RELEASE PIN TO LOCK IN PLACE.</p>  
3	<p>REMOVE REJECT CASSETTE. UNLOCK AND REMOVE ANY NOTES. DO NOT RECYCLE REJECTED NOTES! CLOSE AND LOCK REJECT CASSETTE AND REINSTALL IN DISPENSER.</p>  

STEP	ACTION
4	<p>REMOVE THE NOTE CASSETTE(S). UNLOCK AND MOVE PACKER PLATE TO REAR OF THE CASSETTE. LATCH IN PLACE WITH THE HOLD-BACK LATCH.</p>   <p style="text-align: right;"><i>Note cassettes</i></p>
5	<p>COUNT THE NUMBER OF BILLS THAT REMAIN IN THE CASSETTE, IF ANY.</p> <p>COUNT THE NUMBER OF BILLS THAT ARE BEING ADDED TO THE REMAINING NOTES.</p> <p>THE TOTAL OF THESE AMOUNTS WILL BE ENTERED IN THE “ENTER CASSETTE QUANTITY” PROMPT FOR CASSETTE CLOSE PROCEDURE.</p>
6	<p>PLACE CURRENCY IN THE CASSETTE AND SLOWLY RELEASE THE HOLD-BACK LATCH ALLOWING THE PACKER PLATE TO MOVE FORWARD AGAINST THE NOTES.</p> <p>SLIDE THE CASSETTE BACK INTO THE DISPENSER.</p> <p>PULL THE LOCKING PIN DOWN AND ROTATE SWIVEL PLATFORM 180° COUNTERCLOCKWISE. RELEASE PIN TO LOCK IN PLACE.</p> 

REPLENISH SDD CASSETTE

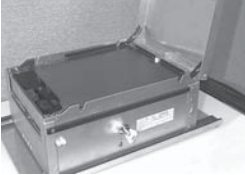

STEP	ACTION
1	<p>UNLOCK/OPEN DISPENSER SECURITY DOOR. GRASP THE CASSETTE HANDLE AND REMOVE THE CASSETTE.</p> 
2	<p>CASSETTE MUST BE PRIMED WITH THE CASSETTE KEY BEFORE INSERTING ON O THE LOADING TRAY. INSERT KEY AND TURN CLOCKWISE TO SHOW GREEN INDICATOR IN WINDOW.</p> <div style="display: flex; justify-content: space-around; align-items: center;">  <div style="text-align: center;">  <p>Green window</p> </div> </div> <p style="text-align: center;">Cassette "primed"</p> <div style="border: 2px solid red; padding: 10px; margin-top: 10px;"> <p style="text-align: center; color: red; font-weight: bold;">***WARNING***</p> <p style="color: red; font-weight: bold;">If RED is indicated in the window on the side of the currency cassette, NEVER attempt to insert the cassette into the dispenser or the loading tray!</p> </div>
3	<p>SLIDE CASSETTE ON TO THE LOADING TRAY. LIFT LID TO EXPOSE THE REJECT TRAY. REMOVE ANY REJECT NOTES. DO NOT RECYCLE REJECTED NOTES!</p> <div style="display: flex; justify-content: space-around;">   </div>

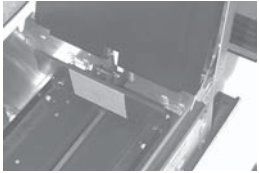
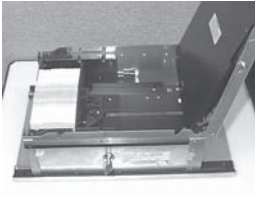
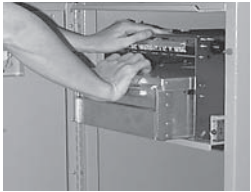
STEP	ACTION
4	<p>LIFT THE REJECT TRAY. PUSH THE PACKER PLATE TO REAR OF CASSETTE AND LATCH IN PLACE.</p> 
5	<p>COUNT THE NUMBER OF BILLS THAT REMAIN IN THE CASSETTE, IF ANY.</p> <p>COUNT THE NUMBER OF BILLS THAT ARE BEING ADDED TO THE REMAINING NOTES.</p> <p>THE TOTAL OF THESE AMOUNTS WILL BE ENTERED IN THE "ENTER CASSETTE QUANTITY" PROMPT FOR CASSETTE CLOSE PROCEDURE.</p>
6	<p>PLACE CURRENCY IN THE CASSETTE AND SLOWLY RELEASE THE HOLD-BACK LATCH ALLOWING THE PACKER PLATE TO MOVE FORWARD AGAINST THE NOTES. CLOSE THE CASSETTE LID.</p> 
7	<p>REMOVE CASSETTE FROM LOADING TRAY. INSERT THE CASSETTE KEY AND "PRIME" THE CASSETTE ("GREEN" INDICATOR). INSTALL THE CASSETTE INTO THE DISPENSER.</p> 

REPLENISH MINIMECH CASSETTE



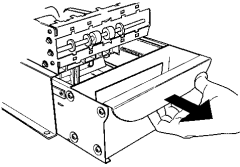
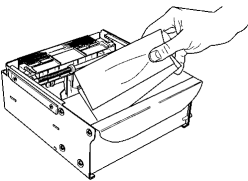
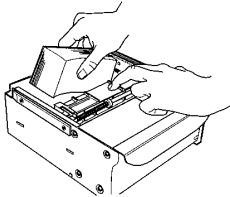

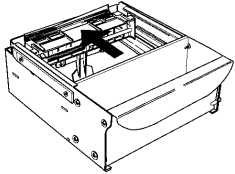
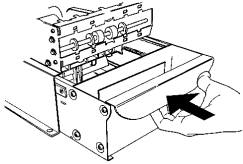

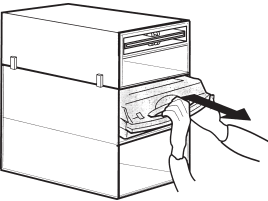

STEP	ACTION
1	<p>UNLOCK/OPEN DISPENSER SECURITY DOOR. GRASP TRAY HANDLE AND REMOVE NOTE CASSETTE</p> 
2	<p>REMOVE ANY REJECTED NOTES FROM THE REJECT COMPARTMENT. DO NOT RECYCLE REJECTED NOTES!</p> 
3	<p>MOVE THE PUSHER PLATE TO THE REAR OF THE TRAY (TOWARDS THE HANDLE).</p> 
4	<p>COUNT THE NUMBER OF BILLS THAT REMAIN IN THE CASSETTE, IF ANY.</p> <p>COUNT THE NUMBER OF BILLS THAT ARE BEING ADDED TO THE REMAINING NOTES.</p> <p>THE TOTAL OF THESE AMOUNTS WILL BE ENTERED IN THE “ENTER CASSETTE QUANTITY” PROMPT FOR CASSETTE CLOSE PROCEDURE.</p>

STEP	ACTION
5	<p>PLACE CURRENCY IN THE CASSETTE. SLOWLY PUSH PACKER FORWARDS AGAINST THE NOTES.</p> 
6	<p>GRASP THE HANDLE AND SLIDE THE NOTE CASSETTE FULLY INTO THE DISPENSER.</p> 

REPLENISH NMD-50 CASSETTE(S)



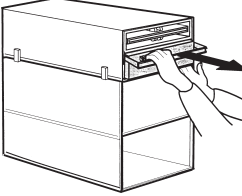

STEP	ACTION
1	<p>UNLOCK/OPEN DISPENSER SECURITY DOOR. GRASP CASSETTE HANDLE WITH ONE HAND WHILE HOLDING MECHANISM WITH THE OTHER.</p> <p>PULL CASSETTE OUT SLIGHTLY, THEN PLACE ONE HAND UNDERNEATH. REMOVE CASSETTE.</p> 
2	<p>PRESS THE GREEN RELEASE BUTTON AND LIFT THE LID. FLIP THE LID BACK FULLY LETTING IT REST ON A FLAT SURFACE.</p> 
3	<p>MOVE THE PACKER PLATE TOWARDS THE REAR.</p> 
4	<p>COUNT THE NUMBER OF BILLS THAT REMAIN IN THE CASSETTE, IF ANY.</p> <p>COUNT THE NUMBER OF BILLS THAT ARE BEING ADDED TO THE REMAINING NOTES.</p> <p>THE TOTAL OF THESE AMOUNTS WILL BE ENTERED IN THE “ENTER CASSETTE QUANTITY” PROMPT FOR CASSETTE CLOSE PROCEDURE.</p>

STEP	ACTION
5	<p>PLACE CURRENCY IN THE CASSETTE AND MOVE PACKER PLATE AGAINST THE NOTES.</p> 
6	<p>EXTEND THE “PAWLS” ON PACKER PLATE FULLY. CLOSE LID AND INSTALL IN DISPENSER.</p> 
7	<p>REMOVE REJECT VAULT.</p> <p>OPEN VAULT BY ROTATING GREEN RELEASE LEVER “COUNTERCLOCKWISE”. GRASP LID AND OPEN. REMOVE ANY REJECTED NOTES. DO NOT RECYCLE REJECTED NOTES!</p> <p>ROTATE GREEN RELEASE LEVER AGAIN AND CLOSE LID. INSTALL REJECT VAULT IN DISPENSER.</p>  

REPLENISH RECEIPT PAPER

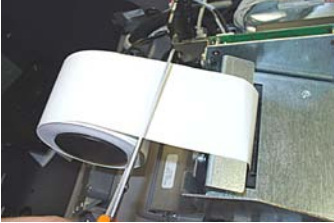
NOTE: THIS PROCEDURE REQUIRES TERMINAL IS POWERED UP.

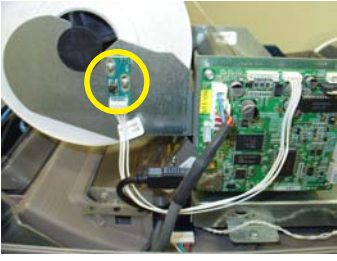
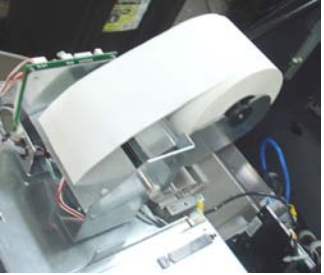
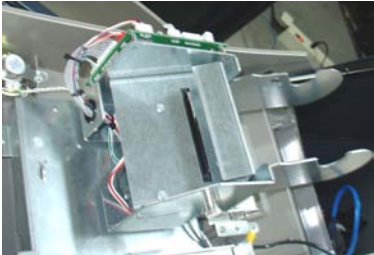
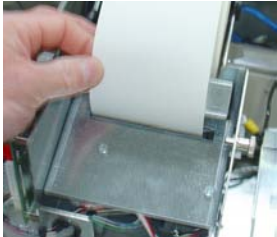
STEP	ACTION	STEP	ACTION
1	<p>OPEN CONTROL PANEL. IF PAPER REMAINS ON ROLL, CUT OR TEAR PAPER BETWEEN ROLL AND PRINTER.</p> 	4	<p>INSTALL NEW PAPER ROLL ONTO SPINDLE.</p> 
2	<p>PRESS THE MANUAL FEED BUTTON TO CLEAR REMAINING PAPER FROM FEED PATH.</p> 	5	<p>INSERT PAPER/SPINDLE INTO PAPER BRACKET. PAPER FEEDS FROM TOP OF ROLL!</p> 
3	<p>REMOVE SPENT PAPER ROLL AND SPINDLE FROM PAPER BRACKET.</p> 	6	<p>FEED END OF PAPER INTO PRINTER TAKE-UP SLOT. PAPER WILL FEED AUTOMATICALLY THROUGH THE PRINTER AND SLIGHTLY OUT FRONT OF UNIT.</p> 

COMBINATION LOCKS

INTRODUCTION

THE SECURITY CABINET CAN BE SECURED USING EITHER A MECHANICAL OR ELECTRONIC COMBINATION LOCK. THIS PAGE COVERS HOW TO OPERATE THE COMBINATION OF EITHER LOCK.

OPERATING THE MECHANICAL LOCK

UNLOCKING THE LOCK

THERE ARE TWO MARKS ON THE DIAL RING. THE INDEX AT THE TOP IS USED FOR OPENING THE LOCK, THE INDEX 30 DEGREES TO THE LEFT IS USED ONLY WHEN CHANGING THE COMBINATION.

THE DIAL SHOULD ALWAYS BE TURNED SLOWLY AND EVENLY. A REVOLUTION IS COUNTED EACH TIME THE SELECTED NUMBER IS ALIGNED WITH THE OPENING INDEX. *DO NOT TURN THE DIAL BACK TO COMPENSATE FOR OVER-DIALING A NUMBER.* IF, WHEN DIALING THE COMBINATION, ANY NUMBER IS TURNED BEYOND THE INDEX, THE ENTIRE SEQUENCE MUST BE REPEATED.

UNLOCKING 3-NUMBER COMBINATIONS (FOR EXAMPLE, “50-25-50”)

1. TURN THE DIAL TO THE *LEFT* AT LEAST FOUR (4) COMPLETE TURNS TO CLEAR THE COMBINATION LOCK TO ACCEPT THE COMBINATION.
2. USING THE ‘OPENING INDEX’, TURN THE DIAL TO THE *LEFT*, STOPPING WHEN ‘50’ IS ALIGNED WITH THE OPENING INDEX, THE *FOURTH* TIME.
3. TURN THE DIAL TO THE *RIGHT*, STOPPING WHEN ‘25’ IS ALIGNED WITH THE OPENING INDEX, THE *THIRD* TIME.
4. TURN THE DIAL TO THE *LEFT*, STOPPING WHEN ‘50’ IS ALIGNED WITH THE OPENING INDEX, THE *SECOND* TIME.
5. TURN THE DIAL SLOWLY TO THE *RIGHT* UNTIL THE BOLT RETRACTS.

OPERATING THE ELECTRONIC LOCK

THE ELECTRONIC LOCK COMBINATION CONSISTS OF SIX DIGITS. UPON ARRIVAL, THE COMBINATION OF THE LOCK SHOULD ALREADY BE PRESET TO *1-2-3-4-5-6*. NOTE: CHANGE THIS COMBINATION! SEE USER MANUAL FOR COMBINATION CHANGE PROCEDURES.

ENTERING THE COMBINATION

1. ENTER THE CURRENT COMBINATION AND CHECK FOR PROPER OPERATION. AFTER EACH KEYPRESS, THE LOCK WILL BEEP. AFTER THE FINAL DIGIT HAS BEEN ENTERED, THE LOCK WILL BEEP *TWICE*, AND THE OPEN PERIOD WILL BEGIN.
2. WHEN A VALID COMBINATION HAS BEEN ENTERED, THE OPERATOR WILL HAVE APPROXIMATELY *4 SECONDS* TO OPEN THE LOCK.
3. TO OPEN THE LOCK, TURN THE *OUTER DIAL* CLOCKWISE.
4. AFTER THE LOCK IS OPENED, THE CABINET DOOR MAY BE OPENED.

LOCKOUT FEATURE

THE LOCK INCLUDES A ‘*WRONG TRY PENALTY*’ LOCKOUT FEATURE THAT PREVENTS ENTRY FROM UNAUTHORIZED PERSONNEL. THIS FEATURE PERFORMS AS FOLLOWS:

- ENTRY OF FOUR (4) CONSECUTIVE INVALID COMBINATIONS STARTS A 5-MINUTE DELAY PERIOD.
 - LED FLASHES RED AT TEN (10) SECOND INTERVALS.
- AT THE END OF THE DELAY PERIOD, TWO (2) MORE CONSECUTIVE INVALID COMBINATIONS WILL RESTART AN ADDITIONAL 5-MINUTE DELAY.